

Jednostranné svodidlo s ochranou pro motocyklisty
Single-sided safety barrier with motorcyclist protection

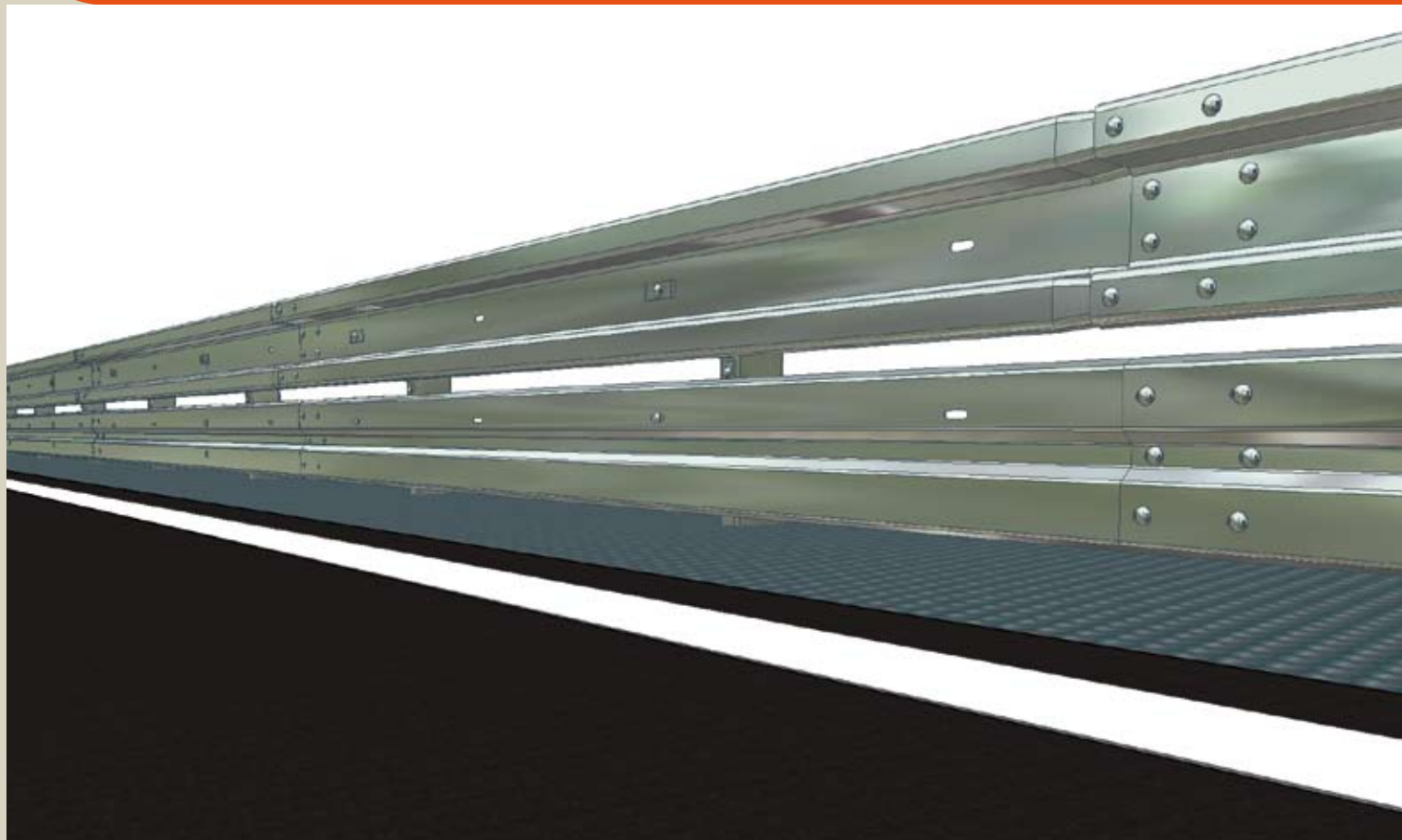

ArcelorMittal

JSAM-M/H1



Úroveň zadržení
Containment level

H1

Test EN 1317

 TB 11 900 kg; 100 km/h

 TB 42 10 000 kg; 70 km/h

Index prudkosti nárazu
Acceleration severity index

A

ASI = 0,7

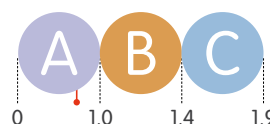

Pracovní šířka
Working width

W4

W=1,1 m, D=0,9 m

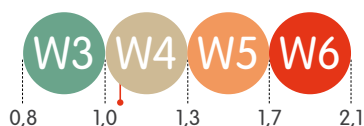

Hmotnost systému
System weight

31,63 kg/m

Jednostranné svodidlo s ochranou pro motocyklisty
Single-sided safety barrier with motorcyclist protection

JSAM-M/H1

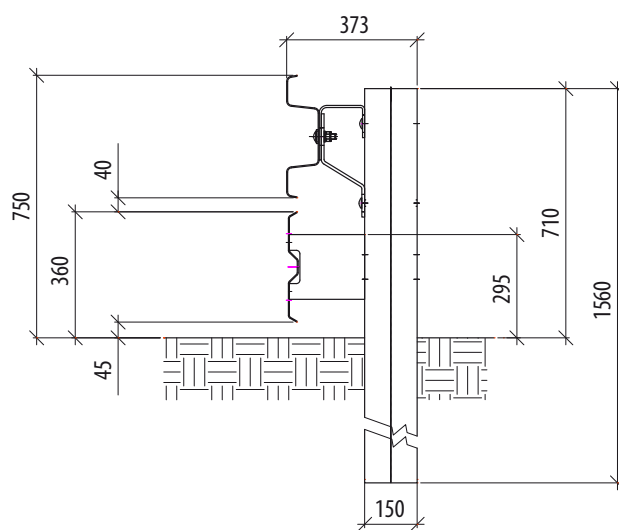
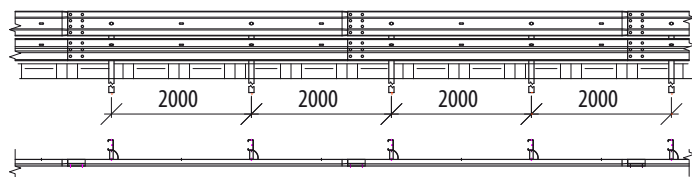
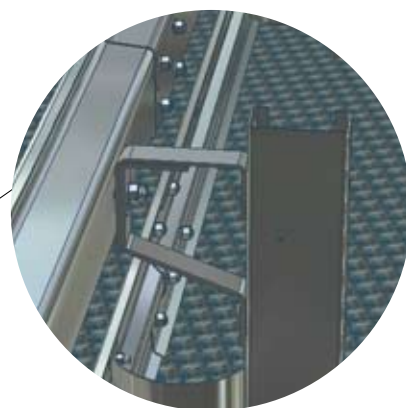
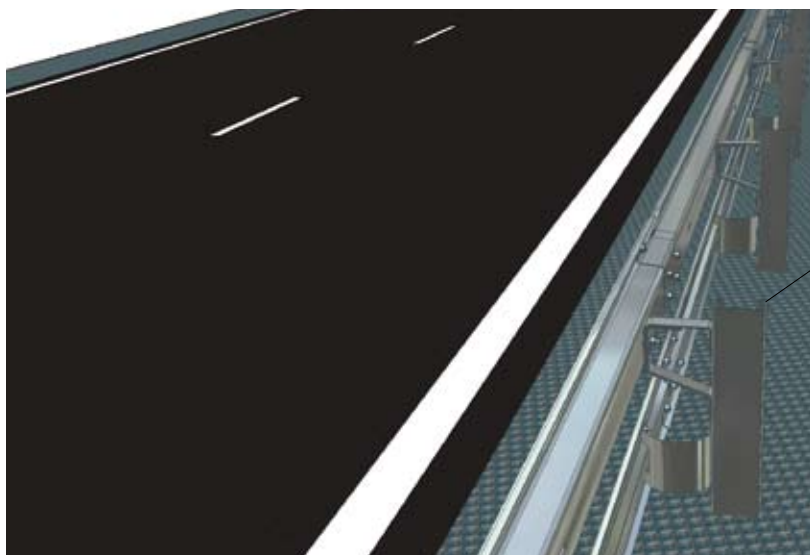

Název dílu	Pozice Position	Materiál Material	Číslo dílu Component No.	Ks/4m Pcs/4m	Designation
Svodnice AM	1	S355MC	60.0.00	1	Barrier strip AM
Spodní pásnice M	2	S355MC	60.0.30	1	Lower beam M
Sloupek C150-1560 M	3	S420MC	61.3.20	2	Post C150 × 75 × 25 M 1760
Distanční díl JM1	4	S355JR	62.0.00	2	Spacer JM1
Distanční díl JM2	5	S355JR	62.0.01	2	Spacer JM2
Distanční díl M	6	S235JR	62.2.00	2	Spacer M

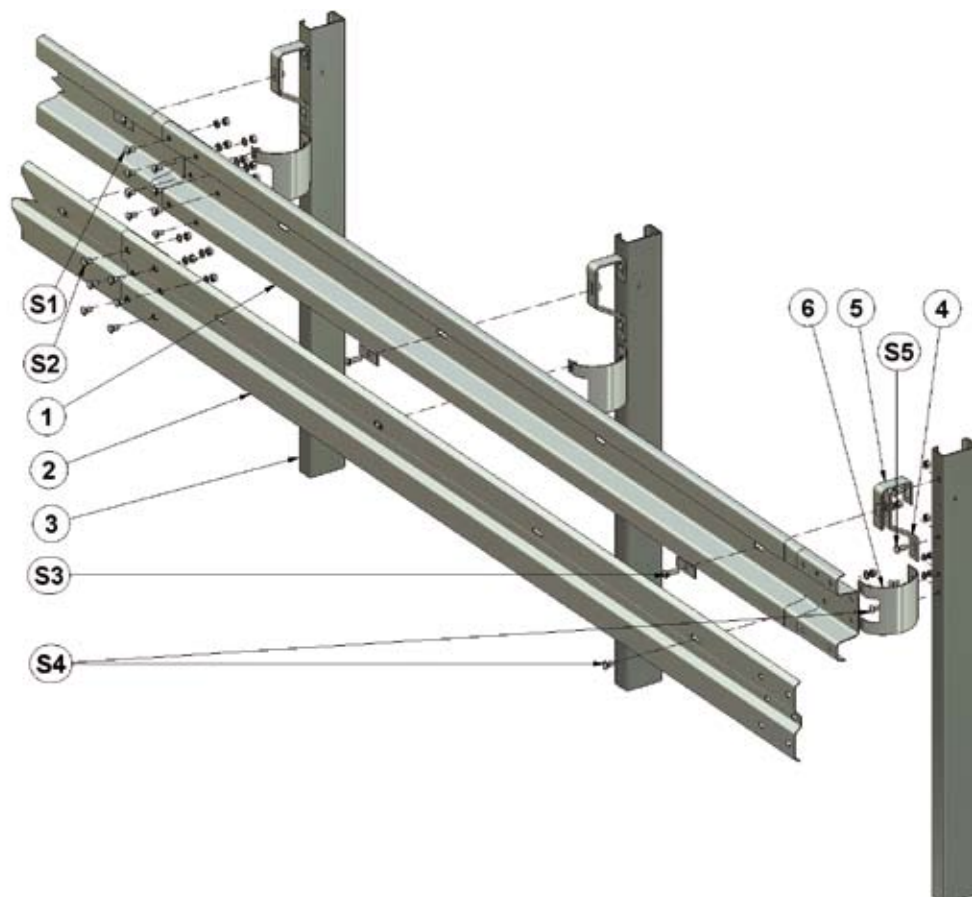

Název dílu	Pozice Position	Číslo dílu Component No.	Ks/4m Pcs/4m	Designation
Šroub s polokruhovou hlavou a noseM M16 × 30-4.6-tZn	S1	59.0.80	8	Cup nib bolt M16×30-4.6-tZn
Podložka 17,5-tZn (ø 17,5/30/3)		59.4.40	8	Washer 17.5-tZn (ø 17,5/30/3)
Matice M 16 - 6 - tZn ISO 4032		59.2.40	8	Nut M16-6-tZn ISO 4032
Šroub s polokruhovou hl. a oválem M16 × 30 - 5.8-tZn	S2	40.03	6	Cup oval neck bolt M16×30 - 5.8-tZn
Podložka 18-tZn (ø 19/40/4)		59.4.41	6	Washer 18-tZn (ø 19/40/4)
Matice M 16 - 6-tZn ISO 4032		59.2.40	6	Nut M16-6-tZn ISO 4032
Šroub s polokruhovou hlavou a noseM M16 × 55-4.6-tZn	S3	59.0.82	2	Cup nib bolt M16 × 55-4.6-tZn
Krycí podložka M16		59.4.80	2	Backplate M16
Podložka 17,5-tZn (ø 17,5/30/3)		59.4.40	2	Washer 17.5-tZn (ø 17,5/30/3)
Matice M 16 - 6-tZn ISO 4032		59.2.40	2	Nut M16-6-tZn ISO 4032
Šroub s polokruhovou hlavou a čtyřhranem M12 × 30-4.6-tZn	S4	59.0.70	6	Cup square neck bolt M12×30-4.6-tZn
Podložka 13-tZn (ø 13/24/2,5)		59.4.20	6	Washer 13-tZn (ø 13/24/2,5)
Matice M 12 - 6 - tZn ISO 4032		59.2.20	6	Nut M12-6-tZn ISO 4032
Šroub s polokruhovou hlavou a noseM M16 × 40-4.6-tZn	S5	59.0.81	4	Cup nib bolt M16 × 40-4.6-tZn
Podložka 17,5-tZn (ø 17,5/30/3)		59.4.40	4	Washer 17.5-tZn (ø 17,5/30/3)
Matice M 16 - 6 - tZn ISO 4032		59.2.40	4	Nut M16-6-tZn ISO 4032

Jednostranné svodidlo s ochranou pro motocyklisty Single-sided safety barrier with motorcyclist protection



ArcelorMittal

JSAM-M/H1

Zádržný systém byl testován a certifikován podle řady norem EN 1317.

Všechny díly jsou zároveň zinkovány podle EN ISO 1461:2009

Restraint system was tested and certified in accordance with the standards EN 1317.

All parts are hot dip galvanized in accordance with the EN ISO 1461:2009



ArcelorMittal Distribution Solutions
Czech Republic, s. r. o.
Vratimovská 689
707 02 Ostrava-Kunčice
Czech Republic

T +420 595 682 625
+420 595 684 590
+420 595 685 627
F +420 595 686 379

E sales.sb@arcelormittal.com
www.arcelormittal.com